

YUEQING HONGYI ELECTRONICS CO., LTD  
乐清市宏一电子有限公司

SPECIFICATION FOR APPROVAL

承认书

CUSTOMER 客户名称	
DESCRIPRION 产品名称	2.0 空中对接系列连接器
ITEM NO 编 号	HY-A20023 (A61)
DATE 日 期	2022-9-11

CUSTOMER ACKNOWLEDGEMENT SEAL

客户承认印签

(APPROVAL) 核准	(ENGINEERING) 工程	(PURCHASE) 采购	(QUALITY) 品质
承认结果： <input type="checkbox"/> 通过 <input type="checkbox"/> 不通过 <input type="checkbox"/> 重新送样			

IS09001

IS014001

IS045001

IATF16949 体系认证

ADD: No. 30, Wenjing Road, Houyu village, Shifan street, Yueqing City, Zhejiang Province

地址：浙江省乐清市石帆街道后屿文景路 30 号

TEL:0577-62380521

FAX: 0577-62381979 P.C:325608

http: //www.zhehongyi.com

E-MAIL:yaohongxiao88@126.com



# 产 品 承 认 书 目 录

1、封面	1-1
2、修订履历	2-2
2、目录	3-3
3、技术规范	4-9
4、产品图纸	11-17

# PRODUCT SPECIFICATION

## 产品规范

### 1、Scope

#### 适用范围

This specification includes the following specifications, including the specification of 2.00mm pitch 2.0 Air Docking series connector

本规范包括下列此种规格包括 2.00mm Pitch 2.0 空中对接系列连接器规格说明

### 2、Appearance and Dimension

#### 外观及尺寸

2.1 Appearance:Product surface without defect、dirt、crack、and mechanical damang,Contactwithout rust,plating not oxidized and not peeled.

产品表面不应有对制品有害的缺陷、污垢、裂痕及机械损伤；接触件无锈蚀、镀层氧化脱落等现象

2.2 Dimension:According to drawings

外形尺寸：依照附图

### 3、Disposal of Material and surface

#### 材料与表面处理

Specification 规格内容	Material 材质	Finish 表面处理	Environmental protection grade 环保等级
Terminal 端子(母)	Phosphor bronze 磷铜 厚 0.20mm	Tin Plating:2.5-5 μ m 镀锡: 2.5-5 μ m	RoHS2.0
Terminal 端子(公)	Phosphor bronze 磷铜 厚 0.20mm	Tin Plating:2.5-5 μ m 镀锡: 2.5-5 μ m	
Housing 胶壳(母)	PBT UL94V-0	Color: White 颜色: 白色	
Housing 胶壳(公)	PBT UL94V-0	Color: White 颜色: 白色	
Wafer 针座	Plastic 塑壳	PBT UL94V-0	
	Contact 插针	Phosphor bronze 磷铜 厚 0.20mm	Tin Plating:2.5~5 μ m 镀锡: 2.5~5 μ m

#### 4、Ratings and applicable wires

##### 额定等级

Item 项目	Standard 规格
Rated Voltage 额定电压	125V AC/DC
Rated Current 额定电流	2A AC/DC
Ambient temperature Range 使用温度范围	-25°C- +85°C
Applicable wire insulation 适用线径	AWG24#-28#

#### 5、Electrical Performance

##### 电气性能

N0. 序号	Ltem 项目	Test mode 试验方法	Requirement 技术要求
5.1	ContactResistance 接触电阻	Male female cooperation, open voltage less than 20mV, current 100mA detection connector at both ends  公母配合, 开放电压20mV 以下, 电流100mA 检测连接器连接器两端	Initial:20mΩ Max 初始: 20mΩ Max  After Test: 30mΩ Max 试验后: 30mΩ Max
5.2	withstandvoltage 耐电压	Mate connectors, apply 500V AC for 1 minute between adjacent terminal or ground  公母配合, 在相邻端子, 端子与地片之间, 使用500V 的交流电1 分钟, 检测连接器	No Breakdown and Flashover  外观无损伤, 无打火花
5.3	InsulationResistance 绝缘电阻	Mate connectors, apply 500V DC between adjacent terminal or ground  公母配合, 在相邻端子, 端子与地片之间, 使用500V 的直流电, 检测连接器	1000MΩ Min

## 6、机械性能

### Mechanical Performance

N0. 序号	Ltem 项目	Test mode 试验方法	Requirement 技术要求
6.1	Terminal crimping wire strength 端子压接导线强度	Fix the crimped terminal, apply axial pull out force on thewire	AWG#24 wire AWG#24 导线 30N Min
		固定铆线后的端子，使电线与端 子分离时所需的最小力量	AWG#26 wire AWG#26 导线 20N Min
			AWG#28 wire AWG#28 导线 13N Min
6.2	Terminal/ Housing Retention Force 端子保持力	Apply axial pull out force at the speed rate of 25.4±3mm/minute on the terminal assembled in the Housing  以每分25.4±3mm 的速率,将端子从Housing 内轴 向拔出力	Per contact: 15N Min 单一接触点: 15N Min
6.3	Insertion & withdraw Force 插拔力	Insert and withdraw Connectors at the speed rate of 25.4±3mm/minute  以每分 25.4±3mm 的速率插入和拔出	Refer to paragraph 8 参照第 8 项

## 7、Endurance Characteristics:

### 环境性能

N0. 序号	Ltem 项目	Test mode 试验方法	Requirement 技术要求
7.1	Repeated Insertion/ Withdrawal 重复插拔	When mated up to 30 cycles repeatedly by the rate of 10 cycles per minute  以每分不超过 10 次的速率,将公母插 拔 30 次	Contact Resistance 接触电阻 30 mΩ Max
7.2	Temperature Rise 温升测试	Mating connectors shall be energized at rating current until thermal stability is achieved, and then measured the temperature rise  公母连接器配合后,加载额定电流直到温 度上升到稳定 状态,然后再测量温升	Temperature Rise 温升测试 30°C Max

NO. 序号	Item 项目	Test mode 试验方法	Requirement 技术要求	
7.3	Vibration test 振动测试	Amplitude: 1.5mm P-P Sweep time: 10~55~10 HZ in 1 minute Duration: 2 hours in each X.Y.Z axials  振幅: 1.5mm P-P 时间: 10~55~10 HZ in 1 minute 持续时间: 每轴向 2 小时	Appearance 外观	No damage 无异常
			Contact Resistance 接触电阻	30 mΩ Max
			Discontinuity 瞬断	1 micro-second Max.
7.4	Heat Resistance 耐热性	85±2°C,96 hours	Appearance 外观	No damage 无异常
			Contact Resistance 接触电阻	30 mΩ Max
7.5	Cold Resistance 耐寒性	-25±3°C,96 hours	Appearance 外观	No damage 无异常
			Contact Resistance 接触电阻	30 mΩ Max
7.6	Humidity 耐湿性	Temperature: 60±2°C Relative Humidity: 90~95% Duration: 96 hours  温度: 60±2°C 湿度: 90~95%(RH) 持续时间: 96 hours	Appearance 外观	No damage 无异常
			Contact Resistance 接触电阻	30 mΩ Max
			Withstand Voltage 耐电压	No Breakdown and Flashover 外观无损伤, 无打火花
			Insulation Resistance 绝缘电阻	1000MΩ Min
7.7	Temperature Cycling 温度变化	5 cycles of: a) -25°C 30 minutes b) +85°C 30 minutes  从-25°C持续30 分钟升至+85°C持续30 分钟, 循环5 次	Appearance 外观	No damage 无异常
			Contact Resistance 接触电阻	30 mΩ Max
7.8	Salt spray 盐雾	24±1 hours exposure to a salt spray from the 5±1% solution at 35±2°C  在温度35±2°C, 盐水浓度5±1%下, 盐水喷雾24±1 小时	Appearance 外观	No damage 无异常
			Contact Resistance 接触电阻	30 mΩ Max

NO. 序号	Ltem 项 目	Test mode 试验方法	Requirement 技术要求	
7.9	Solderability 焊锡附着性	Soldering Time: 3-5sec solder Temperature: 245±5℃  焊接时间: 3-5 秒 焊接温度: 245±5℃	Solder Wetting 焊料润湿	Immersion area above 95%  浸渍面积 95% 以上
7.10	Solder- Resistance 焊锡耐热性	. <p>DIP type PBT material welding heat resistance range: Soldering time:3~5sec solder. Temperature:230±5℃ DIP 型 PA66 材质焊接耐热范围: 焊接时间: 3~5 秒. 焊接温度: 230±5℃</p> <p>DIP type PA46 material welding heat resistance range: Soldering time:3~5sec solder. Temperature:245±5℃ DIP 型 PA46 材质焊接耐热范围: 焊接时间: 3~5 秒. 焊接温度: 245±5℃</p>	Appearance 外观	No damage 无异常



## 8、INSERTION/WITHDRAWAL FORCE

## 综合插入力及拔出力

No. of CTK PIN 数	At Initial 初始值		At 30th 插拔 30 次	No. of CTK PIN 数	At Initial 初始值		At 30th 插拔 30 次
	I. F (N Max) 插入力	W. F (N Min) 拔出力	W. F (N Min) 拔出力		W. F (N Min) 拔出力	W. F (N Min) 拔出力	W. F (N Min) 拔出力
2	20	8	6	12	70	18	16
3	25	8	6	13	75	20	18
4	30	10	8	14	80	20	18
5	35	10	8	15	85	20	18
6	40	12	10				
7	45	12	10				
8	50	14	12				
9	55	14	12				
10	60	16	14				
11	65	16	14				

版本 REV.	日期 DATE	ECN NO.	变更内容 DESCRIPTION	制图 DRAWN

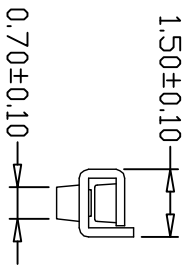
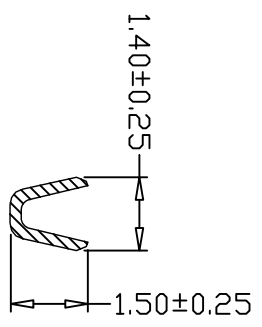
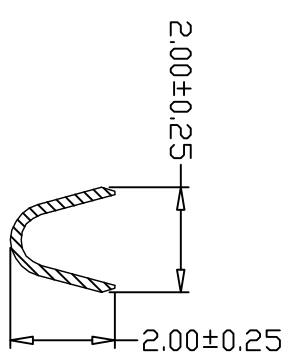
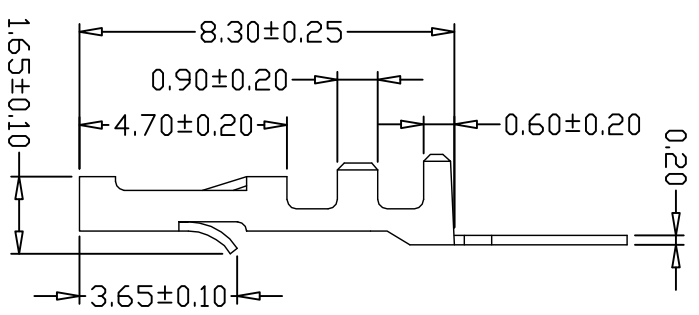
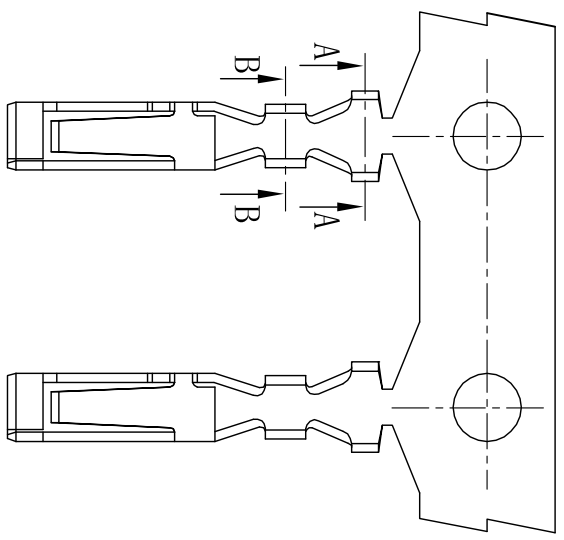

- SPECIFICATIONS
- 1、Current Rating: 2A AC, DC
  - 2、Voltage Rating: 125V AC, DC
  - 3、Temperature Range: -25°C~+85°C
  - 4、Contact Resistance: 20mΩ Max
  - 5、Insulation Resistance: 1000MΩ Min
  - 6、Withstanding Voltage: 500V AC/minute
  - 7、Material: Phosphoric bronze Tin-plated
  - 8、Applicable Wire Sizes: AWG#24~28#

GENERAL TOLERANCE		制图 Mapping	料号 PART NO.	版本 REV.
X $\pm$ 0.25	X $\pm$ 2°	2022. 09. 10	A20023-PT	A
X $\pm$ 0.25	X $\pm$ 1°	审核 Audit	钱岳生	页次 SHEET
.XX $\pm$ 0.15	.XX $\pm$ 0.5°	核准 Approved	张名	1/1
.XXX $\pm$ 0.10	.XXX $\pm$ 0.5°	单位 Units	2022. 09. 11	
		MM SCALE	比例 SCALE	1:1

乐清市宏一电子有限公司  
YueQing HongYi Electronics Co., Ltd

版本 REV.	日期 DATE	ECN NO.	变更内容 DESCRIPTION	制图 DRAWN

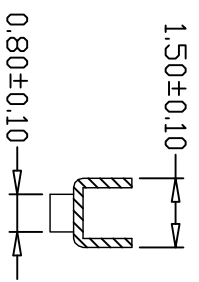
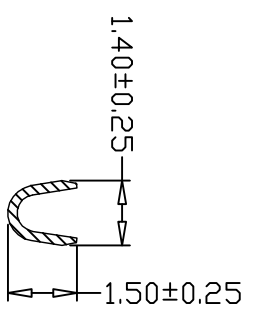
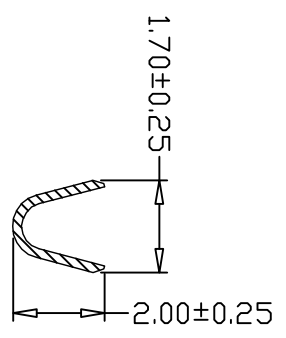
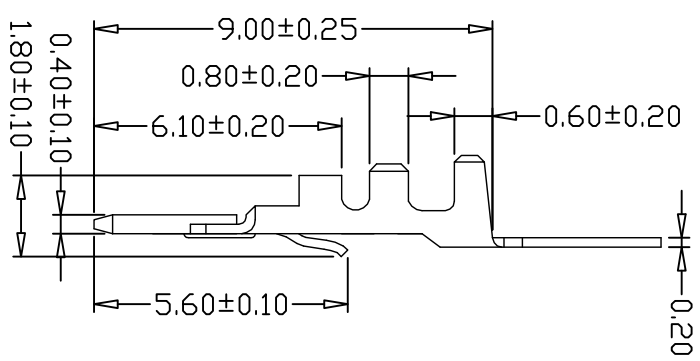
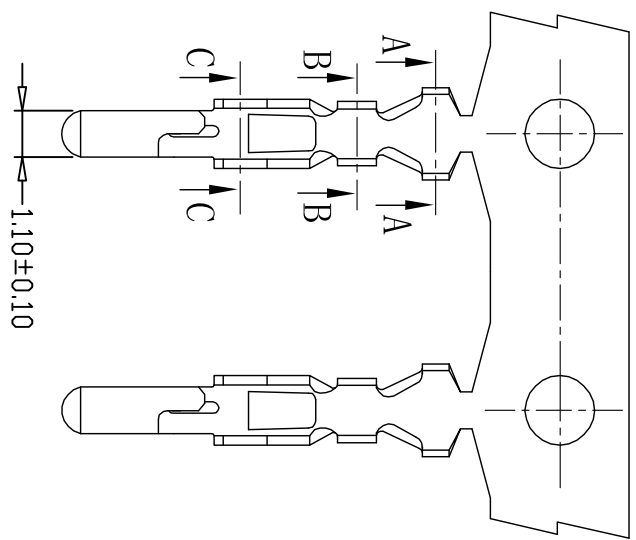

- SPECIFICATIONS
- 1、Current Rating: 2A AC, DC
  - 2、Voltage Rating: 125V AC, DC
  - 3、Temperature Range: -25°C~+85°C
  - 4、Contact Resistance: 20mΩ Max
  - 5、Insulation Resistance: 1000MΩ Min
  - 6、Withstanding Voltang: 500V AC/minute
  - 7、Material: Phosphoric bronze Tin-plated
  - 8、Applicable Wire Sizes: AWG#24~28#

GENERAL TOLERANCE		制图 Mapping	张迎春	料号 PART NO.	A20023-RT	版本 REV.	A
X±0.25	X°±2°	审核 Audit	钱岳生	品名 TITLE	2.0空中对接端子	页次	1/1
X±0.25	X°±1°	核准 Approved	张名	客户料号 CSTM. NO.			
.XX±0.15	.XX°±0.5°	单位 Units	2022. 09. 11	比例 SCALE	1:1	<b>乐清市宏一电子有限公司</b> YueQing HongYi Electronics Co., Ltd	
.XXX±0.10	.XXX°±0.5°						

版本 REV.	日期 DATE	ECN NO.	变更内容 DESCRIPTION	制图 DRAWN

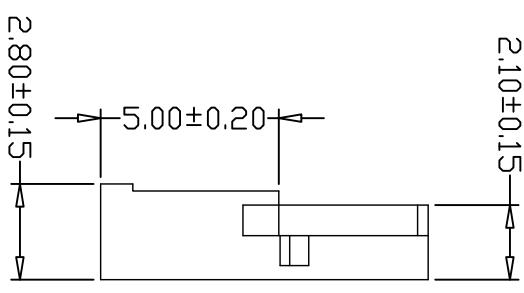
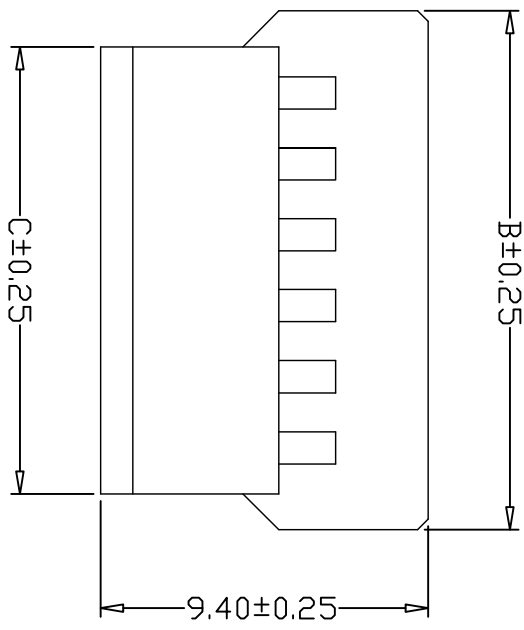
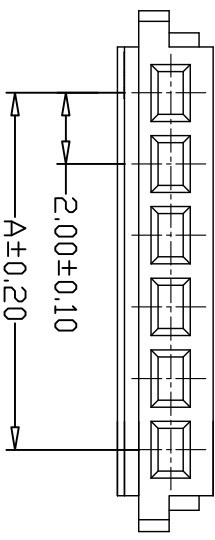

SPECIFICATIONS

- 1、Current Rating: 2A AC, DC
- 2、Voltage Rating: 125V AC, DC
- 3、Temperature Range: -25°C~+85°C
- 4、Contact Resistance: 20mΩ Max
- 5、Insulation Resistance: 1000MΩ Min
- 6、Withstanding Voltage: 500V AC/minute
- 7、Material: PBT, UL94V-0

PIN	尺寸 (mm)		
	A	B	C
-02P	2.00	6.60	4.60
-03P	4.00	8.60	6.60
-04P	6.00	10.60	8.60
-05P	8.00	12.60	10.60
-06P	10.00	14.60	12.60
-07P	12.00	16.60	14.60
-08P	14.00	18.60	16.60
-09P	16.00	20.60	18.60
-10P	18.00	22.60	20.60
-11P	20.00	24.60	22.60
-12P	22.00	26.60	24.60
-13P	24.00	28.60	26.60
-14P	26.00	30.60	28.60
-15P	28.00	32.60	30.60

GENERAL TOLERANCE		制图 Mapping	
X°±0.25	X°±2°	2022、09、10	张迎春
X±0.25	X°±1°	审核 Audit	钱岳生
.XX±0.15	.XX°±0.5°	核准 Approved	张名
.XXX±0.10	.XXX°±0.5°	单位 Units	2022、09、11
		MM SCALE	1:1

料号 PART NO. A20023-nP  
 品名 2.0空中对接(公壳)  
 客户料号 CSTM. NO.  
 版本 REV. A  
 页次 SHEET 1/1

**乐清市宏一电子有限公司**  
 YueQing HongYi Electronics Co., Ltd

版本 REV.	日期 DATE	ECN NO.	变更内容 DESCRIPTION	制图 DRAWN

- SPECIFICATIONS**
- 1、Current Rating: 2A AC, DC
  - 2、Voltage Rating: 125V AC, DC
  - 3、Temperature Range: -25°C~+85°C
  - 4、Contact Resistance: 20mΩ Max
  - 5、Insulation Resistance: 1000MΩ Min
  - 6、Withstanding Voltage: 500V AC/minute
  - 7、Material: PBT, UL94V-0

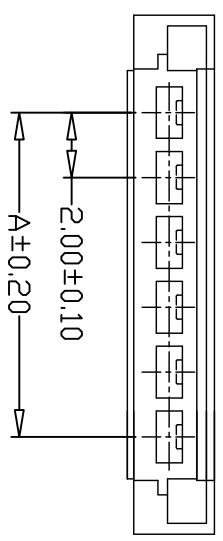
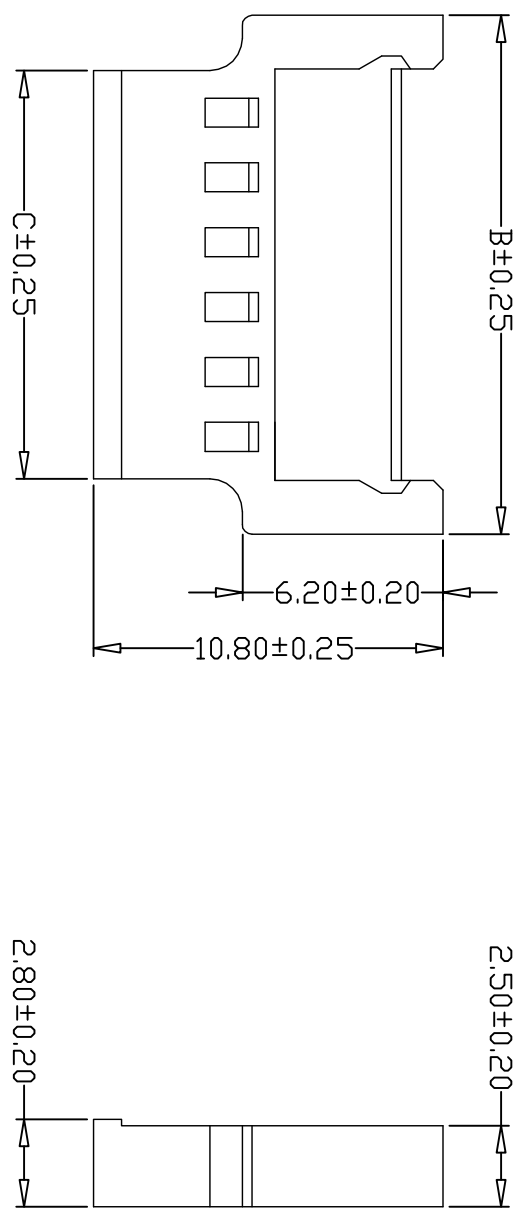

PIN	尺寸 (mm)		
	A	B	C
-02R	2.00	8.00	4.60
-03R	4.00	10.00	6.60
-04R	6.00	12.00	8.60
-05R	8.00	14.00	10.60
-06R	10.00	16.00	12.60
-07R	12.00	18.00	14.60
-08R	14.00	20.00	16.60
-09R	16.00	22.00	18.60
-10R	18.00	24.00	20.60
-11R	20.00	26.00	22.60
-12R	22.00	28.00	24.60
-13R	24.00	30.00	26.60
-14R	26.00	32.00	28.60
-15R	28.00	34.00	30.60

GENERAL TOLERANCE		制图 Mapping	张迎春
$X \pm 0.25$	$X^\circ \pm 2^\circ$	审核 Audit	钱岳生
$.X \pm 0.25$	$X^\circ \pm 1^\circ$	核准 Approved	张名
$.XX \pm 0.15$	$.XX^\circ \pm 0.5^\circ$	单位 Units	2022.09.11
$.XXX \pm 0.10$	$.XXX^\circ \pm 0.5^\circ$	MM	SCALE
		比例	1:1

料号: A20023-nR  
 PART NO.  
 品名: 2.0空中对接(母壳)  
 TITLE  
 客户料号: CUST. NO.  
 版本: A  
 REV.  
 页次: 1/1  
 SHEET

**乐清市宏一电子有限公司**  
 YueQing HongYi Electronics Co., Ltd

版本 REV.	日期 DATE	ECN NO.	变更内容 DESCRIPTION	制图 DRAWN

SPECIFICATIONS

- 1、 Current Rating: 2A AC, DC
- 2、 Voltage Rating: 125V AC, DC
- 3、 Temperature Range: -25°C~+85°C
- 4、 Contact Resistance: 20mΩ Max
- 5、 Insulation Resistance: 1000MΩ Min
- 6、 Withstanding Voltage: 500V AC/minute
- 7、 Material: PBT, UL94V-0  
PIN Phosphoric bronze Tin-plated

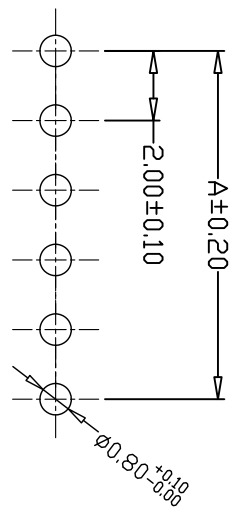
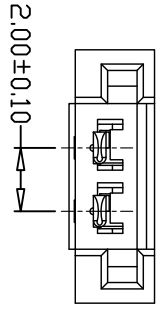

PCB LAYOUT

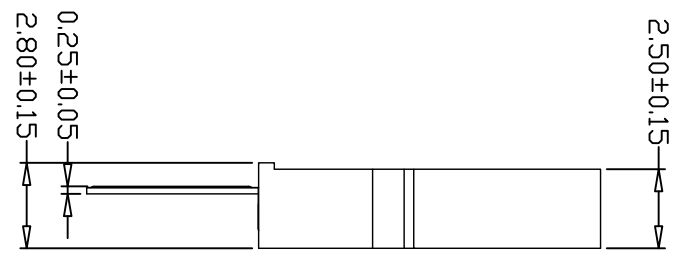
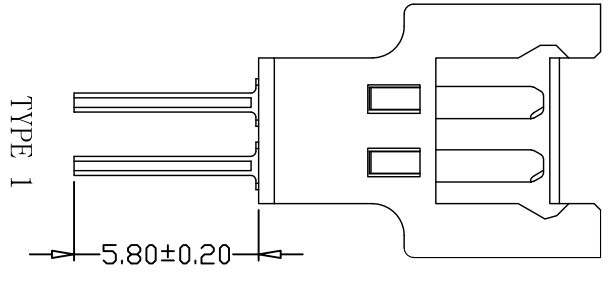
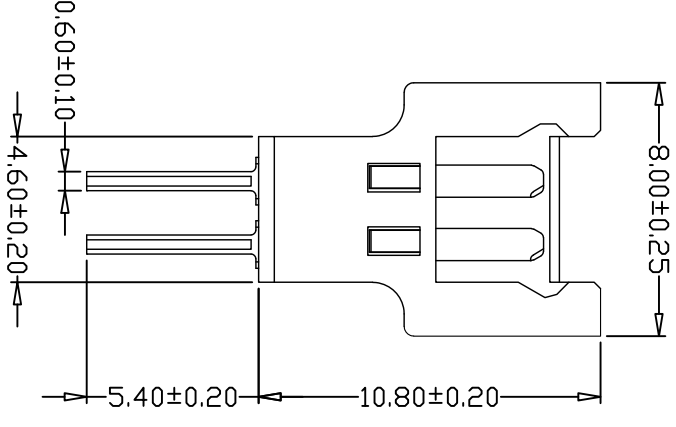

GENERAL TOLERANCE		制图 Mapping	张迎春	料号 PART NO.	A200023-2RA	版本 REV.	A
X <sub>±0.25</sub>	X°±2°	审核 Audit	钱岳生	品名 TITLE	2.0空中对接(细)直针 WAFER DIP TYPE	页次 SHEET	1/1
X <sub>±0.25</sub>	X°±1°	核准 Approved	张名	客户料号 CUST. NO.			
.XX±0.15	.XX°±0.5°	单位 Units	2022. 09. 11	比例 SCALE	1:1		
.XXX±0.10	.XXX°±0.5°					<b>乐清市宏一电子有限公司</b> Yueqing Hongyi Electronics Co., Ltd	

版本 REV.	日期 DATE	ECN NO.	变更内容 DESCRIPTION	制图 DRAWN

SPECIFICATIONS

- 1、Current Rating: 2A AC, DC
- 2、Voltage Rating: 125V AC, DC
- 3、Temperature Range: -25°C~+85°C
- 4、Contact Resistance: 20mΩ Max
- 5、Insulation Resistance: 1000MΩ Min
- 6、Withstanding Voltage: 500V AC/minute
- 7、Material: PBT, UL94V-0  
PIN Phosphoric bronze Tin-plated

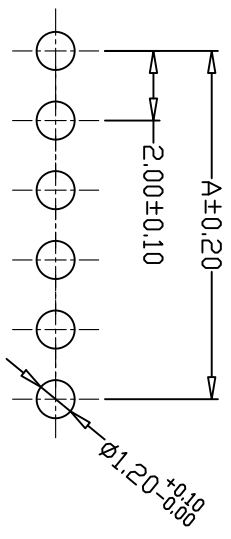
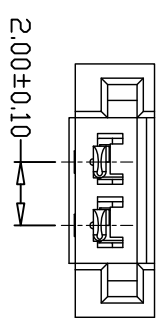

PCB LAYOUT

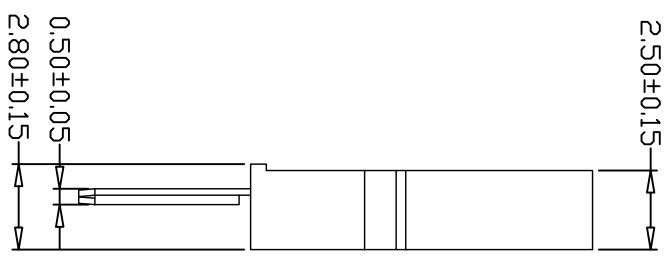
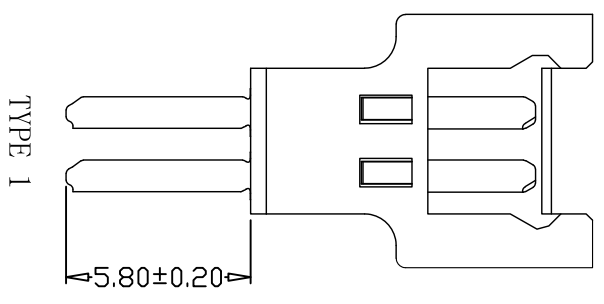
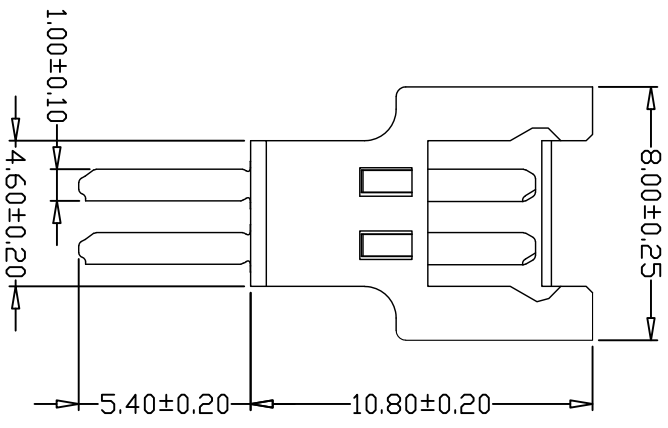

TYPE 1

GENERAL TOLERANCE		制图 Mapping		料号 PART NO.		版本 REV.	
X $\pm$ 0.25	X $\pm$ 2°	张迎春	2022. 09. 10	A20023-2RA1	A		
X $\pm$ 0.25	X $\pm$ 1°	审核 钱岳生	2022. 09. 10	品名 2.0空中对接(粗)直针	页次 1/1		
XX $\pm$ 0.15	XX $\pm$ 0.5°	核准	张名	客户料号	SHEET		
XXX $\pm$ 0.10	XXX $\pm$ 0.5°	Approved	2022. 09. 11	CITM. NO.			
		单位 Units	MM	比例 SCALE	1:1		

乐清市宏一电子有限公司  
Yueqing HongYi Electronics Co., Ltd

版本 REV.	日期 DATE	ECN NO.	变更内容 DESCRIPTION	制图 DRAWN

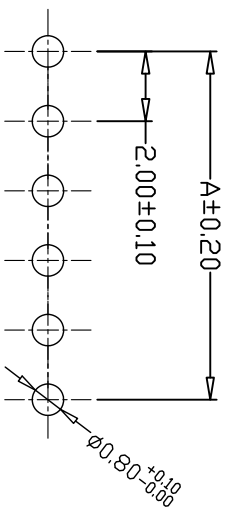
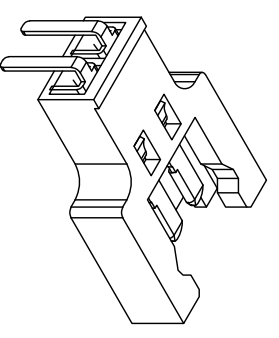
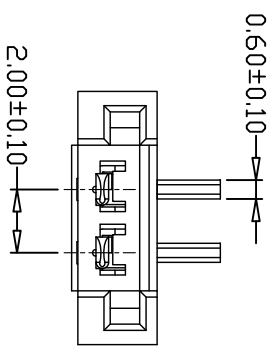

PCB LAYOUT

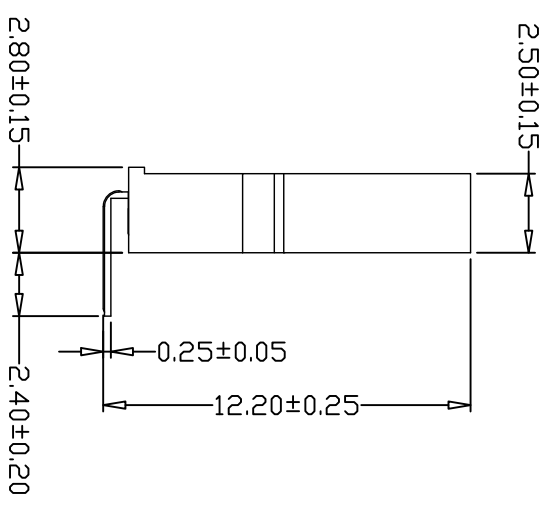
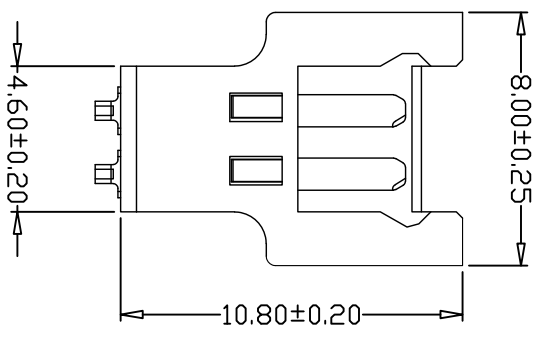

SPECIFICATIONS

- 1、Current Rating: 2A AC, DC
- 2、Voltage Rating: 125V AC, DC
- 3、Temperature Range: -25°C~+85°C
- 4、Contact Resistance: 20mΩ Max
- 5、Insulation Resistance: 1000MΩ Min
- 6、Withstanding Voltage: 500V AC/minute
- 7、Material: PBT, UL94V-0  
PIN Phosphoric bronze Tin-plated

GENERAL TOLERANCE		制图 Mapping		料号 PART NO.		版本 REV.	
X±0.25	X°±2°	2022、09、10	张迎春	A20023-2RAW	A		
X±0.25	X°±1°	审核 Audit	钱岳生	品名 TITLE	2.0空中对接(细)弯针	页次 SHEET	1/1
XX±0.15	XX°±0.5°	核准 Approved	张名	客户料号 CUST. NO.			
XXX±0.10	XXX°±0.5°	单位 Units	2022、09、11				
		MM	比例 SCALE	1:1			

乐清市宏一电子有限公司  
YueDing HongYi Electronics Co., Ltd



版本 REV.	日期 DATE	ECN NO.	变更内容 DESCRIPTION	制图 DRAWN

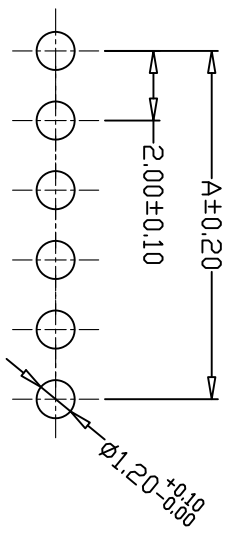
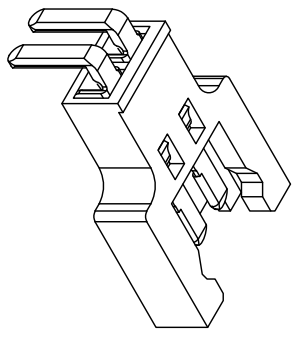
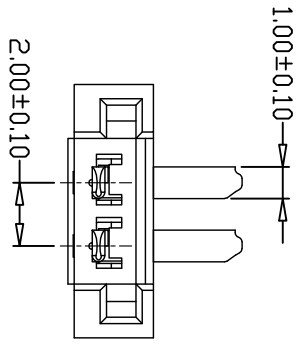

PCB LAYOUT

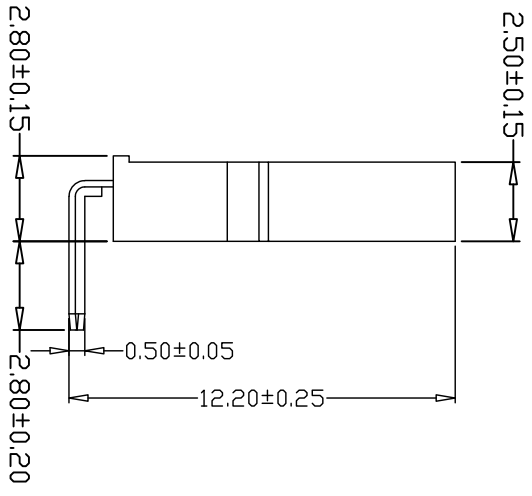
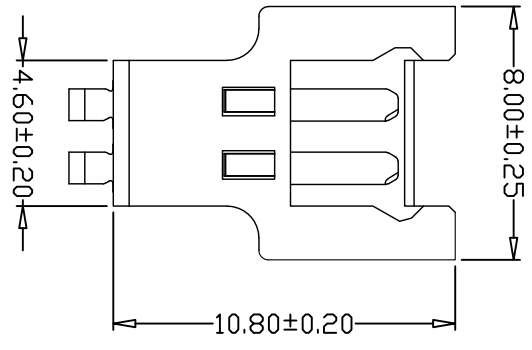

SPECIFICATIONS

- 1、Current Rating: 2A AC, DC
- 2、Voltage Rating: 125V AC, DC
- 3、Temperature Range: -25°C~+85°C
- 4、Contact Resistance: 20mΩ Max
- 5、Insulation Resistance: 1000MΩ Min
- 6、Withstanding Voltage: 500V AC/minute
- 7、Material: PBT, UL94V-0  
PIN Phosphoric bronze Tin-plated

GENERAL TOLERANCE		制图 Mapping	张迎春	料号 PART NO.	A20023-2RAW1	版本 REV.	A
X <sub>±0.25</sub>	X <sub>±2°</sub>	审核 Audit	钱岳生	品名 TITLE	2.0空对接(粗)弯针 WAFER DIP TYPE	页次 SHEET	1/1
X <sub>±0.25</sub>	X <sub>±1°</sub>	核准 Approved	张名	客户料号 CUST. NO.			
XX <sub>±0.15</sub>	XX <sub>±0.5°</sub>	单位 Units	2022. 09. 11	比例 SCALE	1:1	<b>乐清市宏一电子有限公司</b> YueDing HongYi Electronics Co., Ltd	
XXX <sub>±0.10</sub>	XXX <sub>±0.5°</sub>						